

**CT STREET FURNITURE**

# Specification

**Product ID**  
 VED / 0033 40

**Description**  
 Wessex PAS 68 CT40 Stainless Steel (Grade 316) Cycle Stand -  
 Below Ground Fix - Utilises a CT 40 N2/01 CT Bollard

This product is PAS68:2010 approved to the following  
 classifications:  
**40mph Test - Fixed Bollard: V/7500[N2]/64/90:4.0/16.7**

**Installation**  
 For advice about installation of this product, please contact our  
 sales office

**Dimensions**  
 If dimensions are critical please contact sales to confirm

**Brand:** Wessex  
**Category:** Vehicle Defence  
**Sub Category:** Cycle Stand  
**Material:** Stainless Steel  
**Max Width:** 1076mm  
**Above Ground:** 1003mm  
**Below Ground:** 600mm  
**Units:** Each

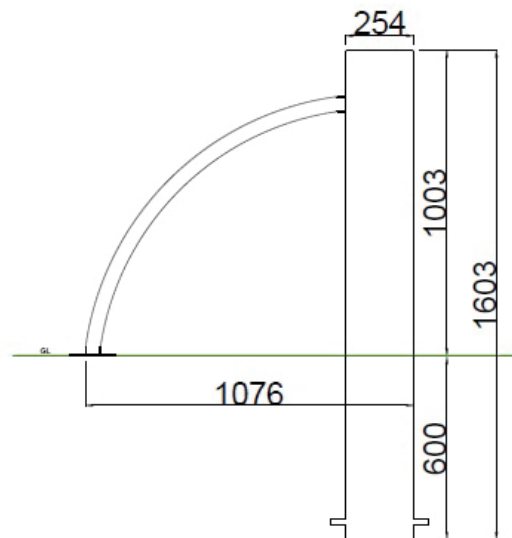

**Policy**  
 Townscape's policy is one of continuous development, and we reserve the right to modify  
 design specification  
 or price without notice. The copyright, design rights and other intellectual property rights in the  
 products and  
 drawings shown and in the text displayed are the property of Townscape Products Limited.

All sizes and weights are nominal and the Company reserves the right to modify dimensions  
 without notice.  
 If dimensions or weights are critical please state when ordering.

